

REMER

RUBINETTERIE



Collezione
CLASS LINE ECO

CLASS LINE ECO



CLASS LINE ECO è una collezione di miscelatori dal design semplice e curato, creata per controllare e ridurre i consumi idrici ed energetici in casa. La combinazione di più tecnologie di risparmio permette infatti di limitare alla sola necessità sia il consumo di acqua che l'utilizzo di acqua calda, senza stravolgere le abitudini quotidiane. La serie è dotata di cartuccia ENERGY SAVING a dischi ceramici Ø 35 mm

CLASS LINE ECO is a collection of mixers with a simple and refined design, created to control and reduce the water and energy consumption in the house. The combination of different saving technologies limit to the actual need both the consumption of water and the use of hot water, without upsetting daily habits. The series is equipped with a Ø 35 mm ceramic disc ENERGY SAVING cartridge





RISPARMIO IDRICO ED ENERGETICO
ENERGY AND WATER SAVING
 WATER SAVING

PROGRAMMA ECO
ECO PROGRAM



Design e tecnologia ambientale
Design and environmental technology

Il programma ECO nasce per il controllo dei consumi, per un reale risparmio sia economico che ambientale. CLASS LINE ECO combina diverse tecnologie di risparmio: cartuccia ENERGY SAVING, aeratore WATER SAVING, anello ANTISCALDING, leva WATER SAVING DYNAMIC.

Funzioni standard incluse:

La cartuccia **ENERGY SAVING** di serie evita la richiesta accidentale e involontaria di acqua calda, consentendo un risparmio energetico.

Questa funzione prevede l'apertura in sola acqua fredda quando la leva è allineata alla bocca del miscelatore; per l'erogazione di acqua calda è invece necessario un movimento volontario della leva verso sinistra.

Aeratore **WATER SAVING** di serie. I miscelatori CLASS LINE ECO sono dotati di serie di un aeratore con limitazione di portata di 6 litri al minuto (disponibile anche nelle varianti da 8, 4, 3 L / min).

Per ottimizzare il risparmio, la collezione CLASS LINE ECO può essere integrata, su richiesta, anche con le seguenti tecnologie opzionali:

Tecnologia **ANTISCALDING** per limitare la temperatura massima dell'acqua erogabile. Questa tecnologia applica una speciale ghiera sulla cartuccia che permette, previa regolazione durante l'installazione, la limitazione della temperatura massima erogabile, impedendo la completa rotazione della maniglia verso l'acqua calda.

Tecnologia **WATER SAVING DYNAMIC**: un promemoria per utilizzare solo la quantità di acqua strettamente necessaria ad ogni operazione. Questo sistema permette di percepire una leggera limitazione all'apertura della leva intorno al 50% dell'erogazione massima d'acqua del miscelatore: un invito per l'utente a non aprire completamente il flusso dell'acqua quando non strettamente necessario. Superando questa leggera resistenza, l'erogazione del flusso al 100% della portata rimane sempre possibile e con la solita morbidezza della leva.

ECO program is created to control consumption for effective economic and environmental savings. CLASS LINE ECO combines different saving technologies: ENERGY SAVING cartridge, WATER SAVING aerator, ANTISCALDING ring, WATER SAVING DYNAMIC lever.

Standard features included:

ENERGY SAVING cartridge as standard equipment avoids the accidental and unintentional request of hot water, thus allowing energy savings.

This function provides for opening in only cold water when the lever is aligned with the mixer spout; for the supply of hot water a voluntary movement of the lever to the left is instead necessary.

WATER SAVING aerator: CLASS LINE ECO mixers are standard equipped with a low flow aerator with a limitation of 6 liters per minute (also available in 8, 4, 3 L / min variants).

To optimize savings, CLASS LINE ECO collection can also be easily integrated, on demand, with the following optional technologies:

ANTISCALDING ring technology to limit the maximum temperature of the water supplied. This technology applies a special ring nut on the cartridge that allows, after adjustment during installation, the limitation of the maximum deliverable temperature, preventing the complete rotation of the lever towards hot water.

WATER SAVING DYNAMIC technology: a reminder to use only the amount of water strictly necessary for each operation.

During the opening phase this system provides a slight limitation of the lever around the 50% of the maximum water supply: an invitation for the user not to fully open the water flow when not strictly necessary. By overcoming this slight resistance, the delivery of the flow at 100% of the flow is always possible and with the usual softness of the lever.



STANDARD ECO



ENERGY SAVING





WATER SAVING

OPTIONS:

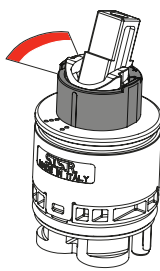

3 L/MIN
 4 L/MIN
 8 L/MIN

COD. 83L6
 STANDARD 6 L/min

OPTIONAL ECO

ANTISCALDING

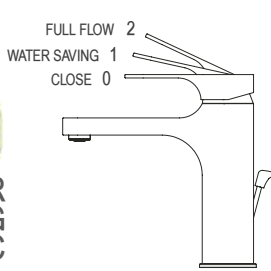
WATER SAVING DYNAMIC



LE10LXLLT6

La serie Eco viene proposta in una gamma di articoli in cui la tecnologia Eco trova migliori benefici nell'uso.

Gli articoli doccia e vasca non sono stati proposti in quanto si presuppone che non vi sia la necessità di apertura in acqua fredda in quanto gli ambienti vasca e doccia sono generalmente utilizzati per loro natura con acqua miscelata/calda.

Per completare la gamma Eco con gli articoli vasca/doccia si consiglia di utilizzare la serie nella versione cartuccia standard.

Le versioni eco vasca e doccia sono comunque disponibili a richiesta.

The Eco series covers a range of items in which the Eco technology finds best benefit of use.

The shower and bathtub items are not offered because it is assumed that there is no need to open in cold water as the bathtub and shower environments are generally used with mixed/hot water for their nature.

To complete the Eco range with bath/shower items, we suggest to use the series in standard cartridge version.

The bath and shower eco versions are anyway available on demand.

CLASS LINE ECO

FLESSIBILI MADE IN ITALY,
IN GOMMA ALIMENTARE EPDM,
RACCORDATI CON
MACCHINE AUTOMATICHE
MADE IN ITALY FLEXIBLE HOSES,
WITH EPDM ALIMENTARY RUBBER,
MADE BY AUTOMATIC
ASSEMBLING MACHINES

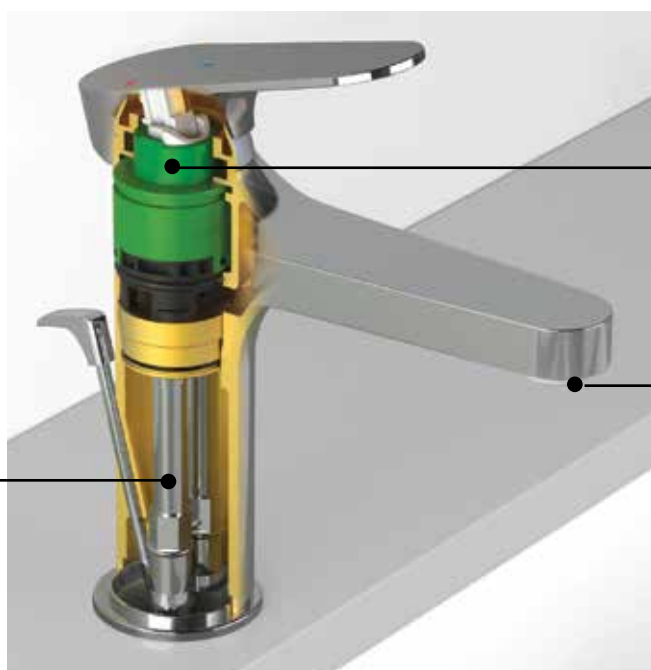

CARTUCCIA MADE IN ITALY
TECNOLOGICA REALIZZATA
CON PLASTICA
ALIMENTARE
ECO FRIENDLY
MADE IN ITALY ECO
FRIENDLY TECHNOLOGIC
CARTRIDGE

AERATORE A
RISPARMIO IDRICO
WATER SAVING
AERATOR

LAVABI ECO - ECO WASHBASIN MIXERS 

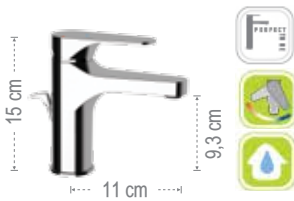

Miscelatore monocomando lavabo.
Single-lever basin mixer.

LE10LT6

con scarico.
with pop-up waste.



LE11LT6

senza scarico.
without waste.



LE12LT6

senza scarico e
senza foro sul corpo.
*without waste and
without body hole.*



Miscelatore monocomando lavabo
alto L.
Single-lever L high basin mixer.

LE10LLT6

con scarico.
with pop-up waste.



LE11LLT6

senza scarico.
without waste.

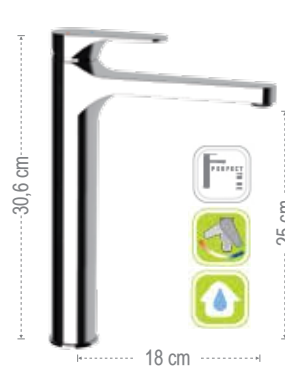

Miscelatore monocomando lavabo
alto XL.
Single-lever XL high basin mixer.

LE10LXLLT6

con click-clack e troppo pieno.
*with click-clack waste
and overflow.*



LE11LXLLT6

senza scarico.
without waste.

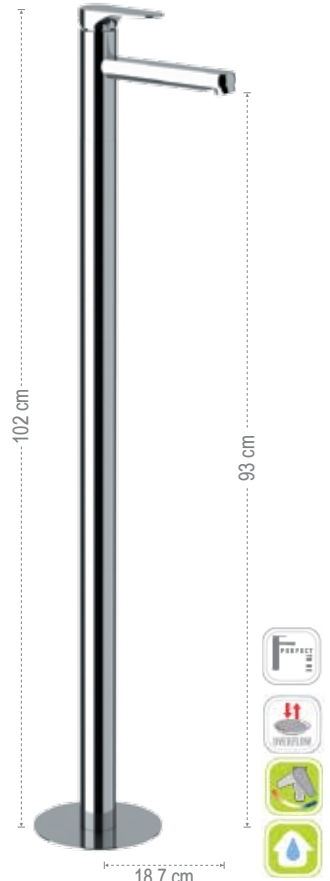

LE18LT6

Miscelatore monocomando lavabo
da terra, con scarico click-clack con
troppo pieno.
*Single-lever mixer for floor mounting,
with click-clack waste with overflow.*

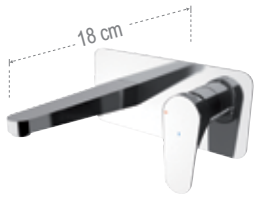

LE15LT6

Miscelatore monocomando a
incasso per lavabo, con piastra
rettangolare in ottone.
*Single-lever built-in basin mixer,
with rectangular wall flange in
brass.*



LE72CLT6

Miscelatore monocomando lavabo
senza scarico, con canna corta
girevole tipo lusso.
*Single-lever basin mixer without
waste, with swivel luxury type
spout.*



BIDET ECO - ECO BIDET MIXERS 

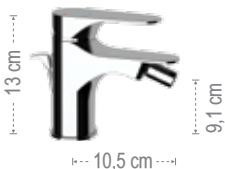

Miscelatore monocomando bidet.
Single-lever bidet mixer.

LE20LT6

con scarico.
with pop-up waste.



LE21LT6

senza scarico.
without waste.



LE65LT6

Miscelatore incasso per shut-off comprensivo di: doccia-shut-off, supporto
doccia-presa acqua su piastra in ottone e flessibile doccia cm 120.
*Built-in shower mixer set including: shut-off, shower holder-water punch on
flange, all in brass and shower flexible cm 120.*



SOFFIONI - SHOWER HEADS



351AXLT8

Soffione con disco anticalcare a snodo Ø 7 cm con limitatore di portata a 8 litri/minuto, con scatola.
Shower-head with anti-limestone jet Ø 7 cm with balljoint with 8 liters/minute flow limiter, box included.



354EC20XLT8

Soffione a pioggia minimale, in abs cromato Ø 20 cm, con getti in silicone anticalcare con limitatore di portata a 8 litri/minuto, con scatola.
c.p. abs shower head, rain jet Ø 20 cm, with anti-limestone silicon jets with 8 liters/minute flow limiter, box included..



357UFM25XLT8

Soffione doccia ultra piatto in acciaio inox lucidato a specchio Ø 25 cm, con limitatore di portata a 8 litri/minuto, con scatola.
Ultra slim stainless steel mirror polished shower head Ø 25 cm, with 8 liters/minute flow limiter, box included.



357UFS25XLT8

Soffione doccia ultra piatto in acciaio inox lucidato a specchio 25x25cm, con limitatore di portata a 8 litri/minuto, con scatola.
Ultra slim stainless steel mirror polished shower head 25x25 cm, with 8 liters/minute flow limiter, box included.



CUCINA ECO -ECO KITCHEN MIXERS



LE72LT6

Miscelatore monocomando monoforo 90°, con bocca alta girevole a "U".
Single-lever sink mixer 90°, swivel "U" spout.



LE42LT6

Miscelatore monocomando per lavello, con bocca alta girevole tipo lusso.
Single-lever one-hole sink mixer, with swivel luxury type spout.



LE42CLT6

Miscelatore monocomando per lavello, con canna corta girevole, tipo lusso.
Single-lever one-hole sink mixer, with high swivel spout, shorter model, luxury type.



LE42ULT6

Miscelatore monocomando per lavello, con bocca girevole a "U".
Single-lever sink mixer, with swivel "U" spout.



LE41LT6

Miscelatore monocomando per lavello a muro con canna girevole.
Single-lever wall mounted sink mixer with swivel spout.



LE41SLT6

Miscelatore monocomando per lavello a muro, con bocca a "S" con canna girevole.
Single-lever wall mounted sink mixer, with "S" swivel spout.



Miscelatore lavabo/vasca con canna fusa lunga 30 cm, con deviatore integrato.
Wall basin/bath single lever mixer with swivel long casted spout 30 cm, with diverter integrated.



LE40LT6

Miscelatore monocomando per lavello con canna girevole.
Single-lever one-hole sink mixer with swivel spout.



LE42RLT6

Miscelatore monocomando monoforo 90° per lavello, con bocca alta girevole ed abbattibile, tipo lusso, modello sottofinestra.
Single-lever one-hole sink mixer, with high swivel and foldable spout, luxury type, under window type.

LE49LT6

con flessibile cm 150 e doccia a 4 funzioni con getti in silicone anticalcare e supporto snodato.
with flexible cm 150 and 4 functions antilimestone handheld shower with silicon jets and swivel shower holder.



LE46LT6

senza kit doccia.
without shower kit.

LEGENDA ICONE - *ICONS LEGEND*



Prodotto Novità
New Product



Acciaio INOX
Stainless Steel



Disponibile in finitura
Finishings available



Perfect Tune:
Prodotto disponibile
in più varianti.
Perfect Tune:
Product available
in different variants.

RUBINETTERIA - *FAUCETS*



Con scarico
With pop-up waste



Con scarico in plastica
With plastic waste



Con Click-Clack
With Click-Clak



Con Click-Clack con Troppo Pieno
With Click-Clak with Overflow



Senza Scarico
Without Waste



Eco
Eco



Cartuccia Energy Saving
Energy Saving Cartridge



Limitatore di Temperatura
Antiscalding



Risparmio Idrico Dinamico
Water Saving Dynamic



Risparmio Idrico
Water Saving



Risparmio Energetico
Energy Saving



Risparmio Idrico e Energetico
Water and Energy Saving

CUCINA - *KITCHEN*



Bocca Girevole
Swivel Spout



Corpo girevole
Swivel body



Doccetta Orientabile
Adjustable handshower



Doccetta Estraibile
Pull-Out Handshower



Bocca Abbattibile
Folding Spout



Doccetta a due funzioni
Two functions hand shower.



Acqua Frizzante
Sparkling Water



Acqua Potabile
Drinking Water

TECNOLOGIA - *TECHNOLOGY*



Touch-Me
Touch-Me



Tempor Touch
Tempor Touch



Con Luce Led
Whit Led Light



Con Batterie Alcaline Include
With Alkaline Batteries included



Alimentazione Elettrica
Power Supply



Azionamento a Sensore
Sensor Control



Con Temporizzazione per Lavatrice/Lavastoviglie
With Timing for washing/machine and Dish/Washer



Con filtro incluso
With filter included



Con Batterie al Litio Include
With Lithium Batteries included



Termostatico
Thermostatic

SOFFIONI - *SHOWER HEADS*



Getto effetto pioggia ad ampia copertura
Wide coverage rain effect



Getto effetto pioggia a risparmio idrico
Water-saving rain effect jet



Con Multigetto
With Multi Jet



Con Getto a Cascata
With Waterfall Jet



Getto Nebulizzato
Nebulized Jet



Cromoterapia
Colortherapy



Autopulente
Self-Cleaning



Con Getti Anticalcare
With Antilimestone Jets

KIT DOCCIA - *SHOWER KIT*



2 Vie
2 Ways



3 Vie
3 Ways



4 Vie
4 Ways



5 Vie
5 Ways



Flessibile Lungo 120 cm
Flexible Length 120 cm



Flessibile Lungo 150 cm
Flexible Length 150 cm



Flessibile Lungo 200 cm
Flexible Length 200 cm

DOCCHETTE - *HANDSHOWERS*



Posizione d'interruzione getto
Stop flow position



Getto intenso esterno con getto effetto pioggia interno
Intense external jet with internal rain effect jet



Getto intenso a risparmio idrico
Intense water-saving jet



Massaggio vigoroso ampia copertura effetto pioggia
Vigorous massage wide coverage rain jet



Getto vigoroso concentrato e getto esterno
Concentrated vigorous jet and external jet



Getto vigoroso concentrato
Vigorous concentrated jet



Getto Aerato Intenso
Intense Aerated Jet



Getto vigoroso effetto pioggia
Vigorous rain effect jet



Getto Vigoroso ed Ampio
Vigorous and Wide Jet



Getto spray ampia copertura e getto intenso esterno a risparmio idrico
Wide coverage spray jet and intense water saving external jet



Getto soft aerato mischiato ad un getto vigoroso a risparmio idrico
Soft aerated jet mixed with a vigorous water-saving jet



Pioggia soft a risparmio idrico
Soft rain water saving



Getto Esterno
External Jet



Con Getti Anticalcare
With Antilimestone Jets

COLONNE DOCCIA - *SHOWER COLUMNS*



Colonna Doccia Girevole
Swivable shower column



Colonna Doccia Telescopica
Telescopic shower column

REMER
RUBINETTERIE



Scan me:



link to website collection

Ufficio Commerciale Italia:

Tel. 0363 364 333
Fax 0363 63 575

Remer Rubinetterie S.p.A.

Via Leonardo da Vinci, 83
20062 Cassano d'Adda (MI) Italy
Tel. +39 0363 364 211
info@remer.eu www.remer.eu

Export Commercial Department:

Tel. +39 0363 364 364
Fax +39 0363 364 300