

REMER

RUBINETTERIE

SERIE
SERIES

ENERGY

CODICE
CODE

EY18

IMMAGINE - IMAGE

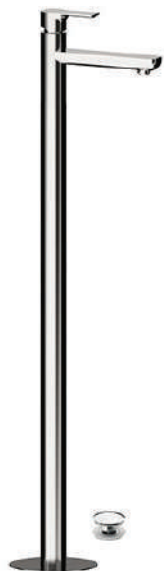

SCHEMA TECNICA - TECHNICAL FEATURES

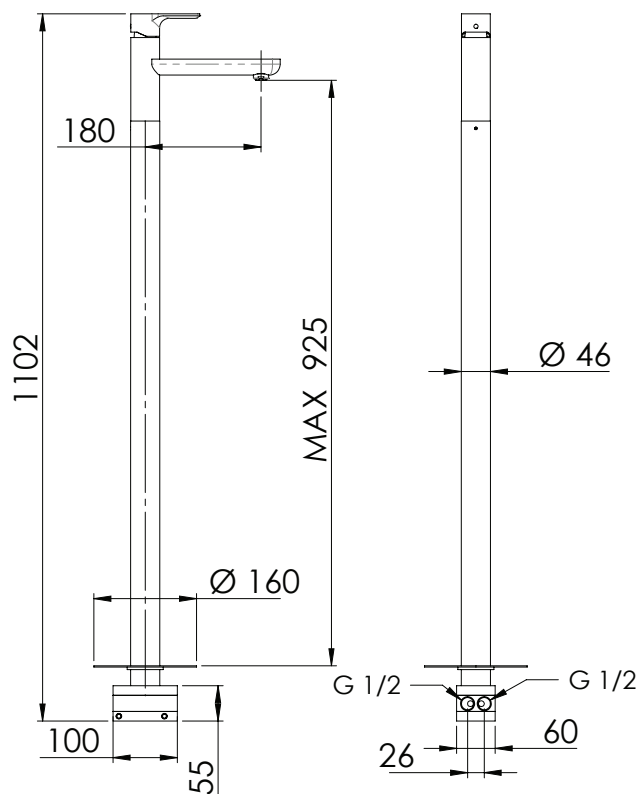

DESCRIZIONE - DESCRIPTION

Miscelatore monocomando lavabo da terra con scarico click-clack con troppopieno.

Single-lever mixer for floor mounting with "click clack" waste with overflow.

CARATTERISTICHE - FEATURES



Disponibile in Finitura
Available in Finishing



Perfect Tune
Perfect Tune



Con Click-Clack con Troppo Pieno
With Click-Clack with Overflow

FINITURE - FINISHING

NO
Nero Opaco
Matt Black

BO
Bianco Opaco
Matt White

NP
Nichel Spazzolato
Brushed Nickel

CR
Cromo
Chrome

COMPONENTI - COMPONENTS



Cartuccia R52
Cartridge R52



Aeratore 83ABP
Aerator 83ABP

REMER Rubinetterie S.p.A.

Via Leonardo Da Vinci, 83 - 20062 Cassano d'Adda (MI) - Italy - Tel. +39 0363 364211 - info@remer.eu - www.remer.eu

REMER

RUBINETTERIE

MISCELATORI FREESTANDING
FLOOR MOUNTING MIXERS

Istruzioni di montaggio
Installation instructions

Remer Rubinetterie S.p.A.
20062 Via Leonardo da Vinci, 83 - Cassano d'Adda (MI) Italy
Tel. +39 0363 364211 - e-mail: info@remer.eu
www.remer.eu

ESEMPIO *DRAWING EXAMPLE*

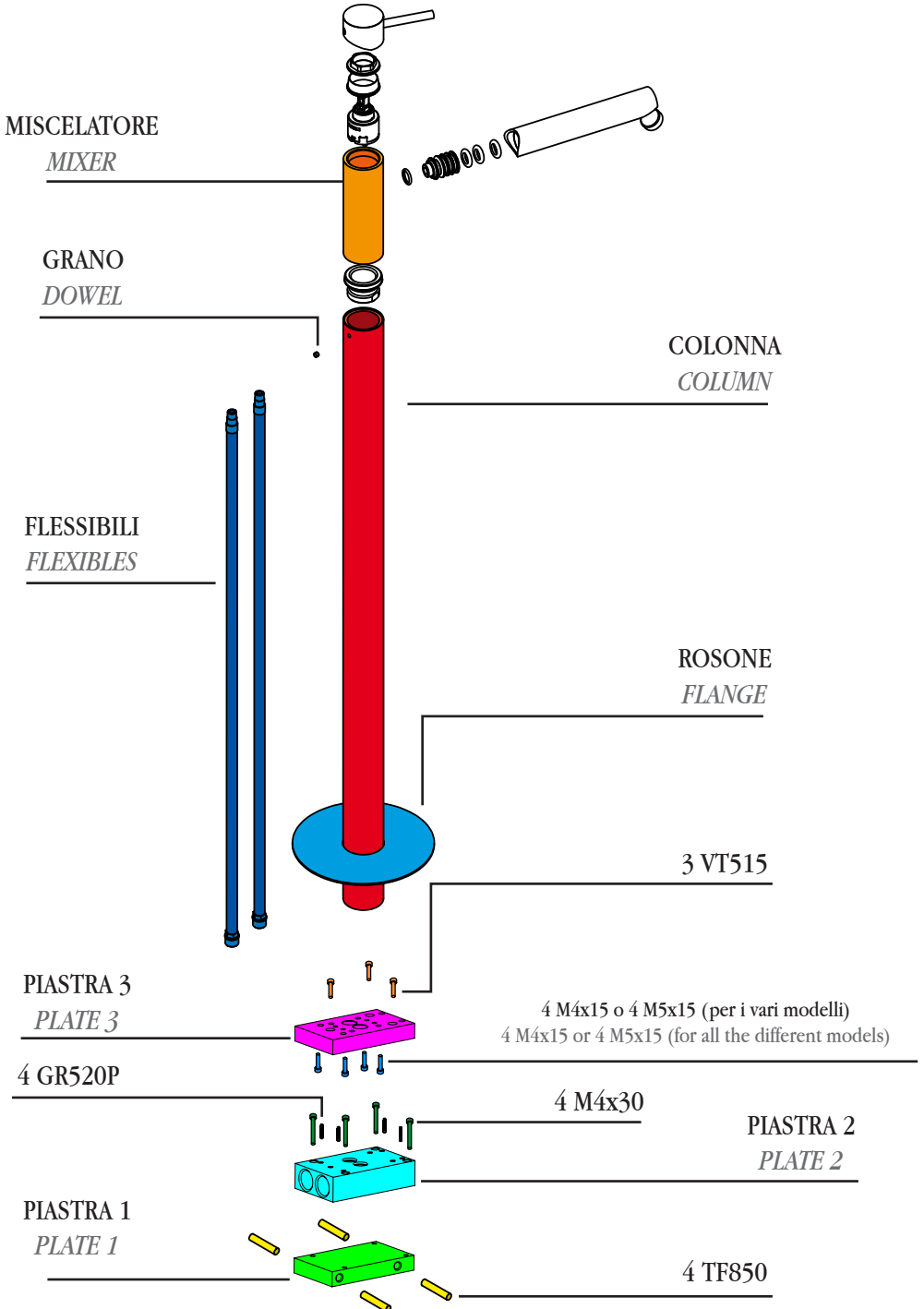

1)

A) Predisporre nel pavimento un alloggiamento profondo 65 mm per la PIASTRA 1.

Avvitare le 4 viti TF850 alla PIASTRA 1.

B) Cementare la PIASTRA 1 nel pavimento.

A) Set a deep housing into the floor for PLATE 1, minimum depth 65 mm.

Tighten the 4 screws to PLATE 1.

B) Cement PLATE 1 into the floor.

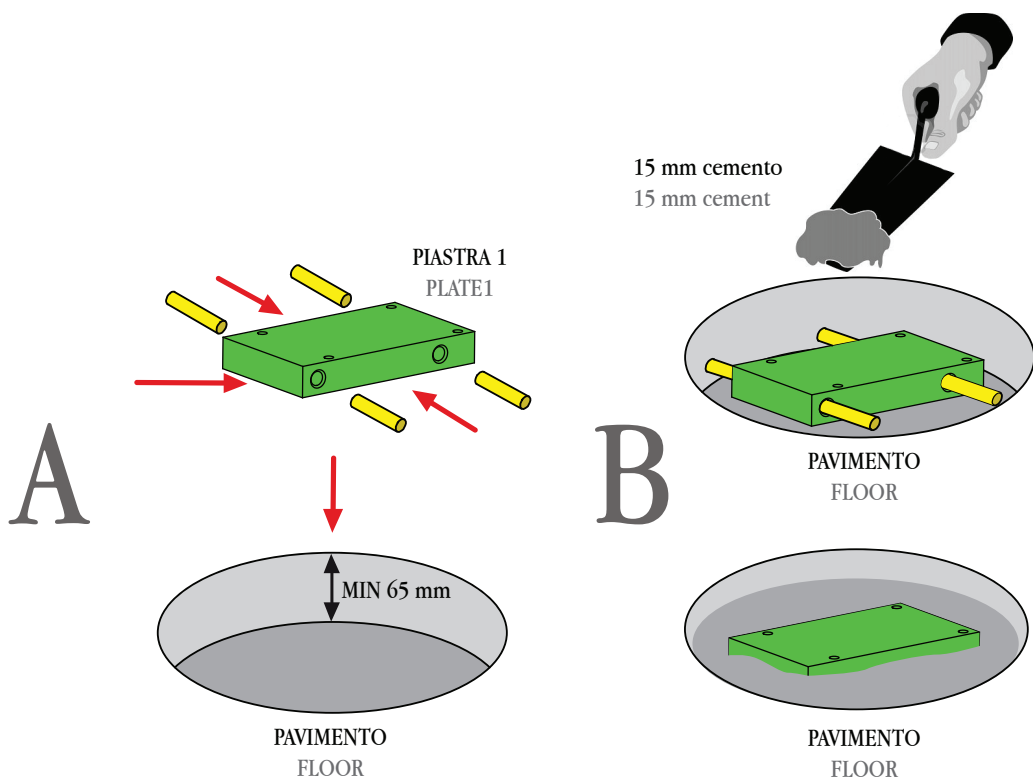

2)

Avvitare i 2 flessibili agli attacchi del miscelatore, infilarli nella colonna e poi fissare il miscelatore alla colonna con i grani.

Screw the two flexible hoses to the mixer connections, insert them into the column and then fix the mixer to the column with the dowels.

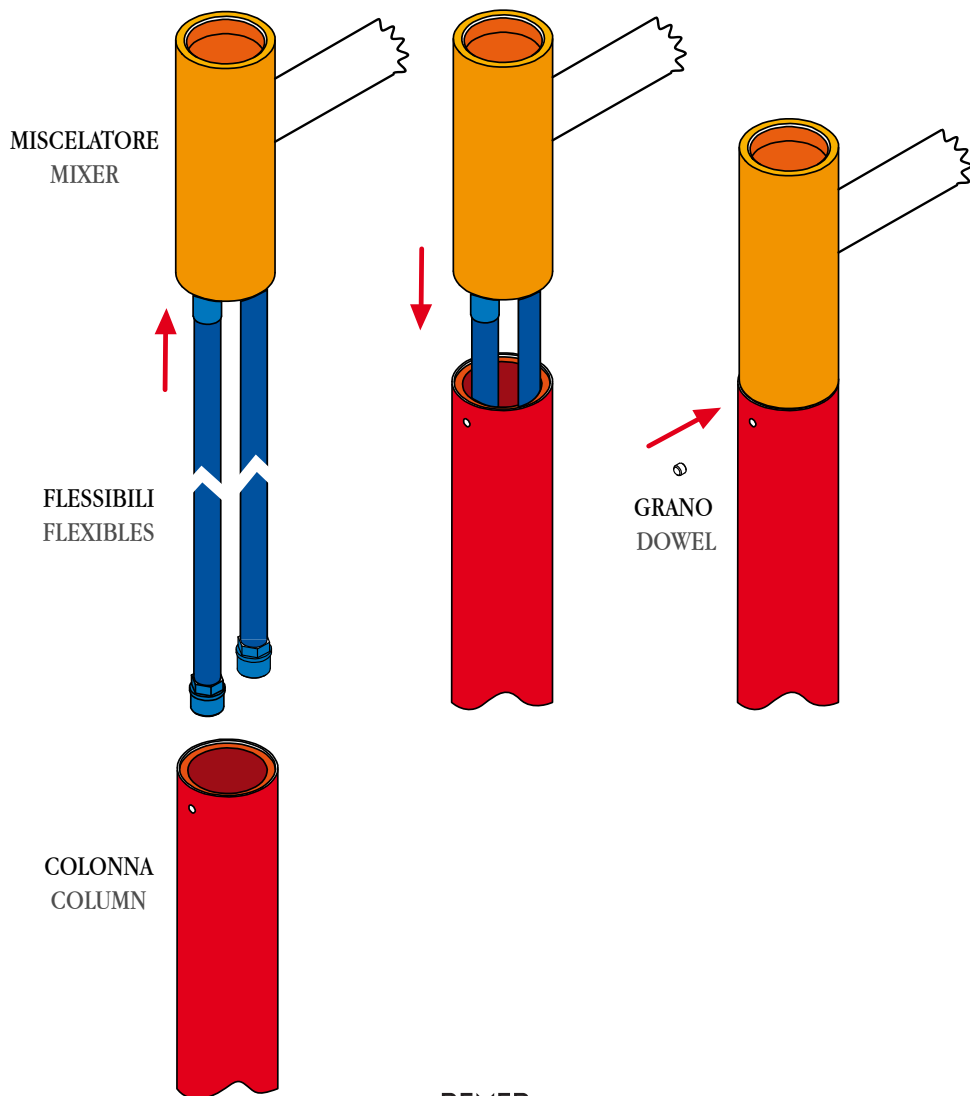

3)

Infilare il rosone per 30 cm sulla colonna dopo averla lubrificata leggermente per evitare di danneggiare la cromatura.

Slightly lubricate the column to prevent damage to chrome plating and then slide the flange on the column itself along 30 cm.

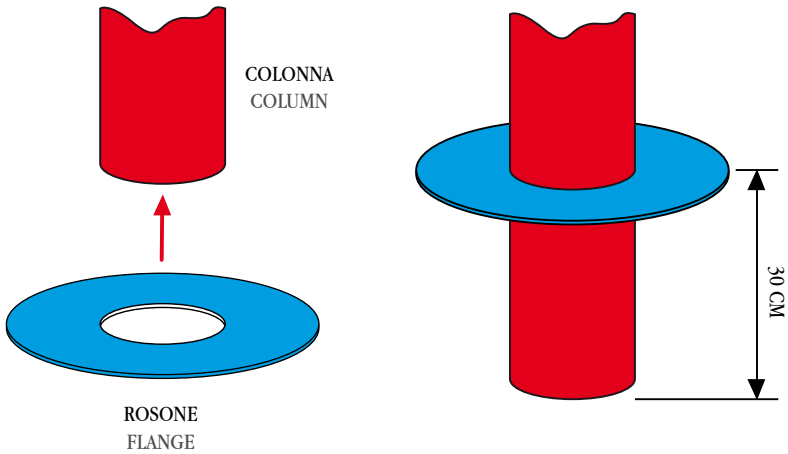

4)

Avvitare i flessibili nella PIASTRA 3 (sigillare con teflon).

Avvitare la PIASTRA 3 alla colonna con le 4 viti M4x15 (M5x15 versione quadrata).

Screw the flexible hoses into PLATE 3 (seal with PTFE tape).

Screw PLATE 3 to the column with four M4x15 screws (M5x15 square type).

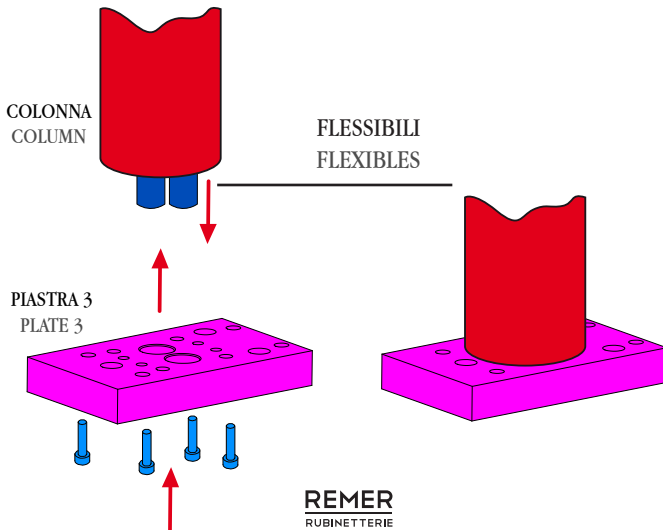

5)

Fissare la PIASTRA 2 alla PIASTRA 1 con le 4 viti M4x30.
Per regolare la planarità agire sui 4 grani GR520P
e poi stringere le viti.

Fix PLATE 2 to PLATE 1 with four M4x30 screws.

To adjust levelness, act on four GR520P dowels and then tighten the screws.

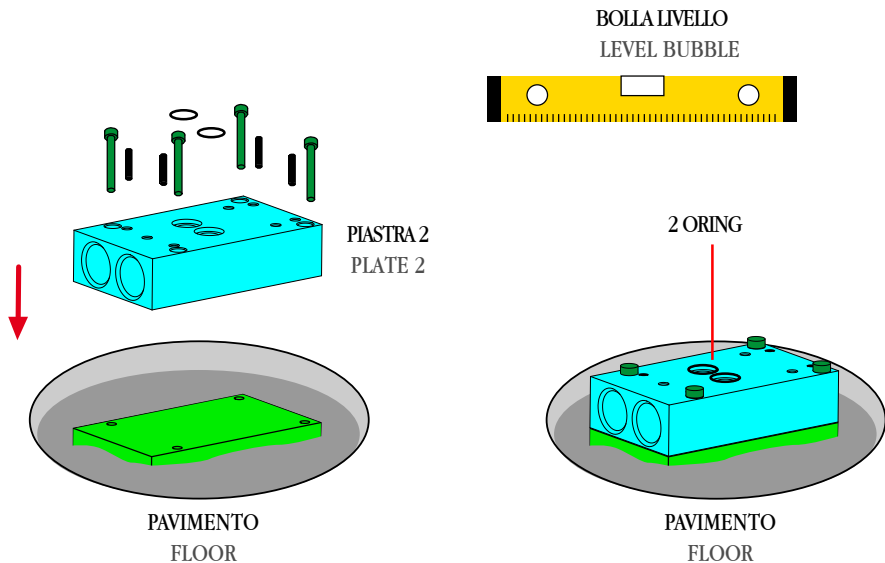

6)

Avvitare la PIASTRA 3 alla PIASTRA 2 con le 3 viti VT515.

Screw PLATE 3 to PLATE 2 with three VT515 screws.

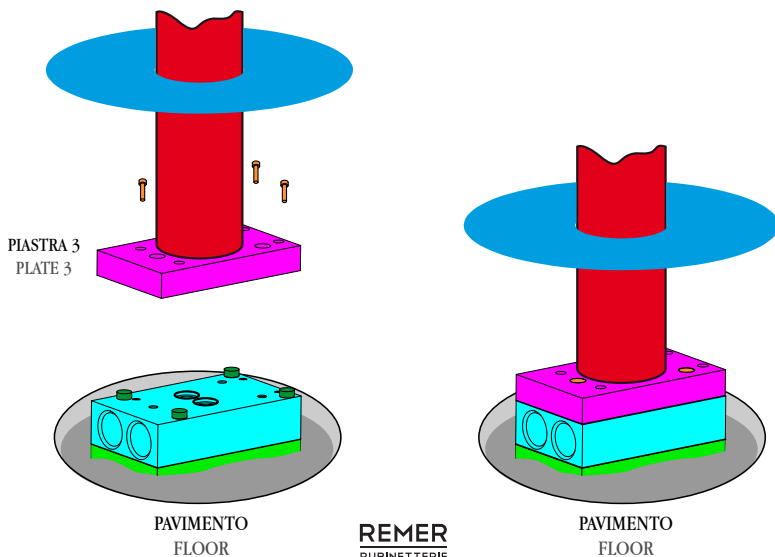

7)

Collegare i 2 flessibili per acqua fredda e calda alla PIASTRA 2.

Connect the two cold and hot water flexible hoses to PLATE 2.

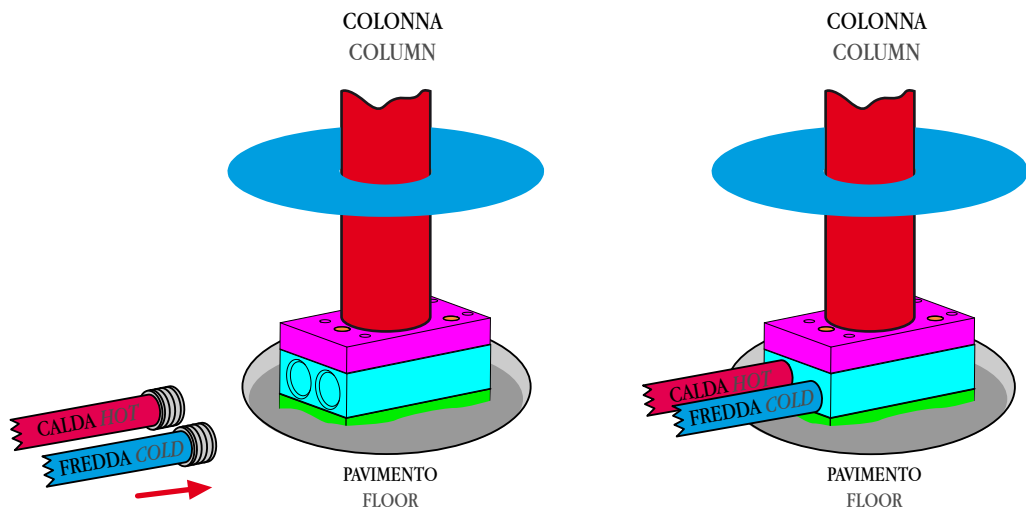

8)

Verificare che tutte le connessioni non presentino perdite e, dopo il collaudo generale, abbassare il rosone fino al pavimento.

Tra il rosone ed il pavimento creare un cordone di silicone per sigillare.

Check all connections for any leak and, after the general testing, slide the flange down to the floor.

Between the flange and the floor, create a silicone sealing layer.

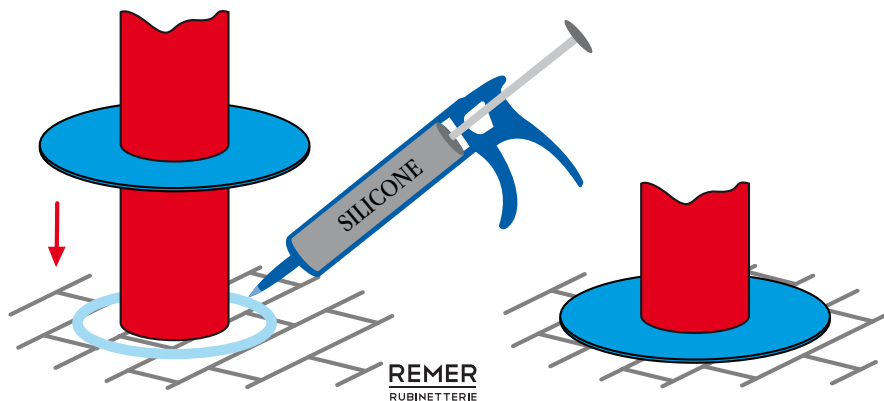

REMER

RUBINETTERIE

Remer Rubinetterie S.p.A.

20062 Via Leonardo da Vinci, 83 - Cassano d'Adda (MI) Italy

Tel. +39 0363 364211 - e-mail: info@remer.eu

www.remer.eu