

PIANTA
PLAN

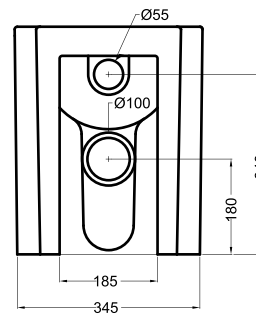

VISTA POSTERIORE
REAR VIEW

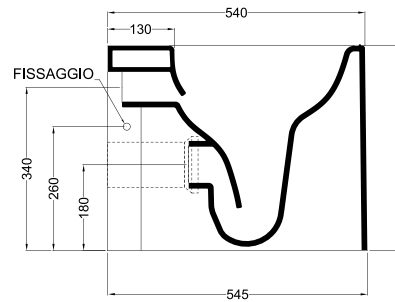
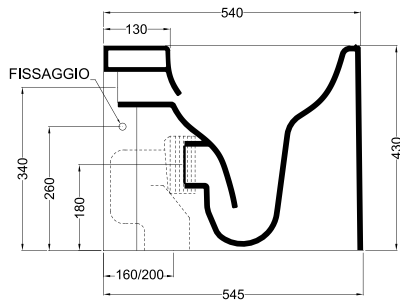
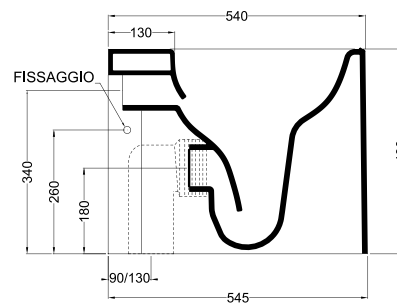
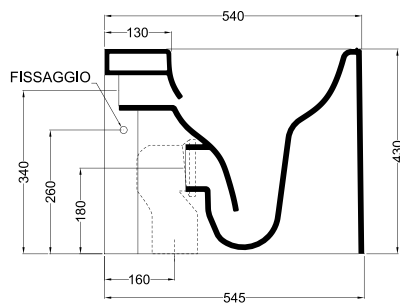

SEZIONE LONGITUDINALE
LONGITUDINAL VIEW

N.B.: Le misure indicate possono subire una variazione dello 0.8 % circa, dovuta ad usura stampi o a piccole variazioni delle caratteristiche tecniche relative alle materie prime che compongono l' impasto.

N.B.: Indicated size could have a variation of about 0,8 % due to the usure of the moulds or the small variations of the raw materials' technical characteristics used in the mixture.

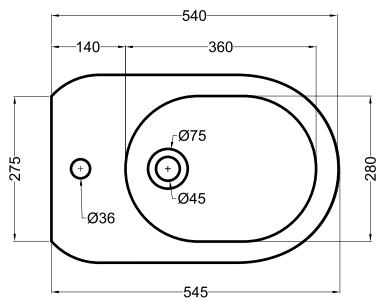

PIANTA
PLAN

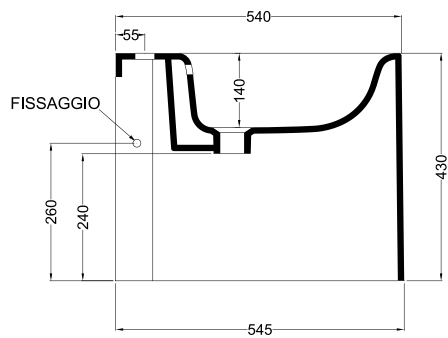

SEZIONE LONGITUDINALE
LONGITUDINAL VIEW

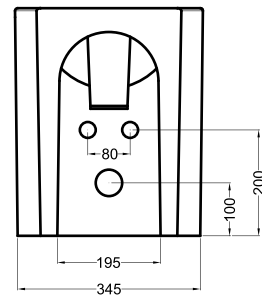

VISTA POSTERIORE
REAR VIEW

N.B.: Le misure indicate possono subire una variazione dello 0.8 % circa, dovuta ad usura stampi o a piccole variazioni delle caratteristiche tecniche relative alle materie prime che compongono l' impasto.

N.B.: Indicated size could have a variation of about 0,8 % due to the usure of the moulds or the small variations of the raw materials' technical characteristics used in the mixture.